

M9391A PXIe Vector Signal Analyzer

1 MHz to 3 GHz or 6 GHz



Table of Contents

Overview	3
Technical Specifications and Characteristics	4
Definitions for specifications	4
Recommended best practices in use	4
Block diagram	5
Frequency	6
Amplitude	8
Dynamic range	11
Spectral purity	14
Data acquisition	16
Measurement speed	17
Format specific measurement data	19
Environmental and physical specifications	23
System requirements	24
Software	25
Setup and Calibration Services	26
Configuration and Ordering Information	28

Overview

Be ready for tomorrow - today

RF requirements keep growing while timelines keep shrinking. To help ease the technical and business pressures, the right test solution provides continuity in measurements and longevity in capability. The Keysight Technologies, Inc. M9391A PXIe vector signal analyzer (PXI VSA) is the next logical step in RF signal analysis.

The M9391A PXI VSA, combined with the M9381A PXIe vector signal generator provides a complete solution for fast, high quality measurements optimized for RF manufacturing test environments.

To help you get proven results even faster, Keysight's PXI VSA can be used with X-Series measurement applications for modular instruments, 89600 VSA software and SystemVue. These software applications enable you to investigate, validate and test your RF communications designs.

From fully modular hardware to software leverage to worldwide support, the PXI VSA is the low-risk way to manage change and be ready for tomorrow—today.

Product description

The M9391A PXI VSA is a modular vector signal analyzer for frequencies from 1 MHz to 6 GHz and up to 160 MHz analysis bandwidth. The M9391A is comprised of four individual PXI modules - M9350A downconverter, M9214A digitizer, M9301A synthesizer and M9300A frequency reference. A single M9300A frequency reference can be shared between multiple instruments to minimize footprint.

The flexible, modular design of the M9391A enables you to efficiently scale to multi-channel signal analysis to test multiple-input, multiple-output (MIMO) devices. Capability can also be scaled with options for memory, frequency range and modulation bandwidth which can be easily upgraded in the field.

Applications

- Power amplifier and front-end-module design validation and manufacturing
- Radio transceiver design validation and production test
- MIMO and multi-channel device test

Reference solutions

Application specific reference solutions, a combination of recommended hardware, software, and measurement expertise, provide the essential components of a test system. The following reference solutions include the M9391A PXI VSA as a hardware component.

- RF PA/FEM characterization and test, Reference Solution for the industry's fastest envelope tracking test, rapid waveform download, tight synchronization, automated calibration and digital pre-distortion. For more information, see www.keysight.com/find/solution-padvt
- LTE/LTE-A multi-channel test, Reference Solution for faster insight into carrier aggregation and spatial multiplexing designs. For more information, see www.keysight.com/find/solution-LTE



Figure 1. M9391A PXIe vector signal analyzer with four modules consisting of the M9214A digitizer, M9301A synthesizer, M9350A downconverter and M9300A frequency reference.

Technical Specifications and Characteristics

Definitions for specifications

Temperatures referred to in this document are defined as follows:

- Full temperature range = Individual module temperature of 25 to 75 °C, as reported by the module, and environment temperature of 0 to 55 °C.
- Controlled temperature range = Individual module temperature of 40 to 51 °C, as reported by the module, and environment temperature of 20 to 30 °C.

Specifications describe the warranted performance of calibrated instruments. Data represented in this document are specifications under the following conditions unless otherwise noted.

- Calibrated instruments have been stored for a minimum of 2 hours within the full temperature range
- 45 minute warm-up time
- Calibration cycle maintained
- When used with Keysight M9300A frequency reference and Keysight interconnect cables

Characteristics describe product performance that is useful in the application of the product, but that is not covered by the product warranty. Characteristics are often referred to as Typical or Nominal values and are italicized.

- **Typical** describes characteristic performance, which 80% of instruments will meet when operated within the controlled temperature range.
- **Nominal** describes representative performance that is useful in the application of the product when operated within the controlled temperature range.

Recommended best practices in use

- Use slot blockers and EMC filler panels in empty module slots to ensure proper operating temperatures. Keysight chassis and slot blockers optimize module temperature performance and reliability of test.
- Set chassis fan to high at environmental temperatures above 45 °C
- Maintain temperature stability for best multi-channel phase coherence
 - Set chassis fans to maximum
 - Maintain stable ambient temperature
 - Perform warm-up with session open and representative acquisition waveform running

Conversion type operating range

Conversion types	Frequency range
Auto	1 MHz to 3 or 6 GHz
Image protect	1 MHz to 3 or 6 GHz
Single high	400 MHz to 3 or 6 GHz
Single low	1.1 GHz to 3 or 6 GHz

Additional information

- Mixer level offset modifies the receiver gain prior to the first mixer of the receiver. A negative setting improves distortion (i.e., TOI) at the cost of noise performance (i.e., DANL). A positive setting improves noise performance at the cost of distortion.
- Performance described in this document applies for module temperature within ± 3 degrees of comprehensive alignment, unless otherwise noted.
- When used with a Keysight M9018A PXIe chassis, comprehensive alignment requires chassis FPGA version 1.05 or greater.
- When configured for multi-channel, phase-coherent operation (shared synthesizer configuration), instrument level warranted specifications only apply to the M9391A which was previously calibrated with the M9301A synthesizer, showing a valid calibration indicator. For all other M9391A channels, specifications revert to typical performance. If using an external LO distribution unit, such as the V2802A LO distribution network, specifications for all M9391A channels revert to typical performance.
- All graphs contain measured data from one unit and is representative of product performance within the controlled temperature range unless otherwise noted.
- The specifications contained in this document are subject to change.

Technical Specifications and Characteristics

Block diagram

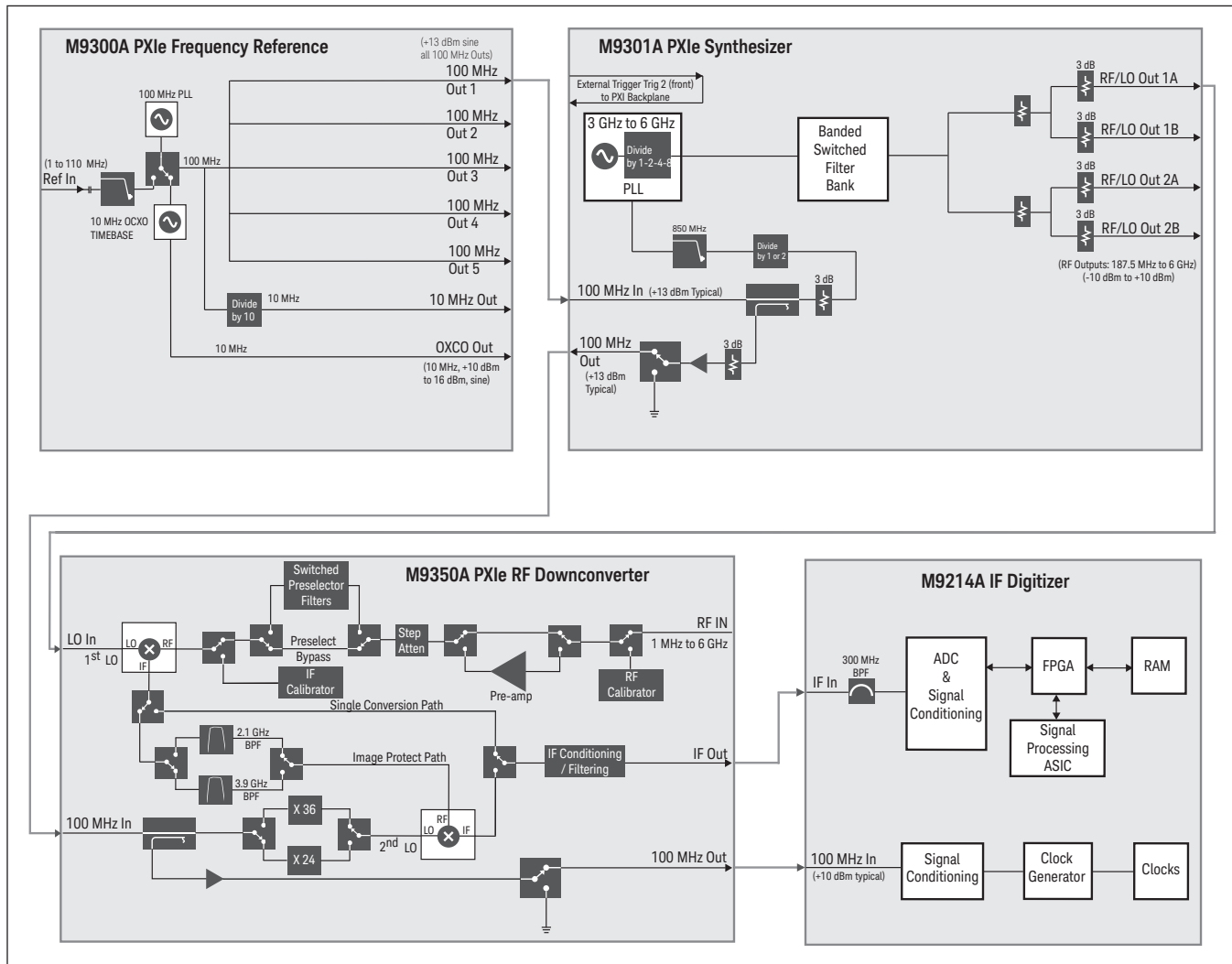

Figure 3. M9391A PXIe vector signal analyzer block diagram with four modules consisting of the M9301A synthesizer, M9350A downconverter, M9214A digitizer and optional M9300A frequency reference.

Technical Specifications and Characteristics

Frequency

Frequency range and resolution

Option F03	1 MHz to 3 GHz
Option F06	1 MHz to 6 GHz
Tuning resolution	0.001 Hz

IF frequency

	Nominal
15 MHz filter	326 MHz
40 MHz filter	240 MHz
160 MHz filter	300 MHz

Analysis bandwidth ¹

Maximum bandwidth	Option B04	40 MHz
	Option B10	100 MHz
	Option B16	160 MHz

Frequency switching speed ^{2,3}

List mode switching speed ⁴	Sample rate	Acquisition bandwidth	Standard, nominal	Option UNZ, nominal
Baseband frequency offset change ⁵	≤ 100 MHz	≤ 80 MHz	5 ms	27 μs
	> 100 MHz to < 180 MHz	> 80 MHz to < 144 MHz	5 ms	102 μs
	≥ 180 MHz	≥ 144 MHz	5 ms	15 μs
Arbitrary frequency change			5 ms	320 μs
Non-list mode switching speed ⁶			Standard, nominal	Option UNZ, nominal
Baseband frequency offset change ⁵			5 ms	310 μs
Arbitrary frequency change			5 ms	2.3 ms

1. Instantaneous bandwidth (1 dB bandwidth) available around a center frequency over which the input signal can be digitized for further analysis or processing in the time, frequency or modulation domain.
2. When used with the M9018A PXIe chassis (2-link configuration: 1 x 8 [factory default]) and M9036A PXIe embedded controller.
3. Settled to within 1 kHz or 1 ppm, whichever is greater of final value. Does not include data acquisition or processing time. Amplitude settled to within 0.1 dB. Channel filter set to none. Applies for all conversion types.
4. Time from trigger input to frequency and amplitude settled. Minimum IQ sample rate ≥ 6 MHz. Minimum spectrum acquisition ≥ 4.8 MHz. Minimum power acquisition channel filter bandwidth ≥ 4.8 MHz. For lists with first point < 400 MHz or for frequency changes from > 400 MHz to < 400 MHz, add 40 ms.
5. Baseband offset can be adjusted ± from carrier frequency within limits determined by RF analysis bandwidth and IF filter bandwidth. Synthesizer frequency and amplitude are not changing. Baseband offset settled to within 1 kHz.
6. Mean time from IVI command to carrier frequency settled to within 1 kHz or 1 ppm, whichever is greater. Amplitude settled within 0.1 dB. Simultaneous carrier frequency and amplitude switching. For frequency changes from > 400 MHz to < 400 MHz, add 40 ms.

Technical Specifications and Characteristics

Frequency (continued)

Frequency reference (M9300A PXIe frequency reference module)

Reference outputs

100 MHz Out (Out 1 through Out 5)

Amplitude ≥ 10 dBm 13 dBm, *typical*

Connectors 5 SMB snap-on

Impedance 50 Ω , *nominal*

10 MHz Out

Amplitude 9.5 dBm, *nominal*

Connectors 1 SMB snap-on

Impedance 50 Ω , *nominal*

OCXO Out

Amplitude 11.5 dBm, *nominal*

Connectors 1 SMB snap-on

Impedance 50 Ω , *nominal*

Frequency accuracy

Same as accuracy of internal time base or external reference input

Internal timebase

Accuracy \pm [(time since last adjustment x aging rate) \pm temperature effects
 \pm calibration accuracy]

Frequency stability

Aging rate

Daily $< \pm 0.5$ ppb/day, after 72 hours of warm-up

Yearly $< \pm 0.1$ ppm/year, after 72 hours of warm-up

Total 10 years $< \pm 0.6$ ppm/10yrs, after 72 hours of warm-up

Achievable initial calibration accuracy
(at time of shipment) $\pm 5 \times 10^{-8}$

Temperature effects

20 to 30 °C $< \pm 10$ ppb

Full temperature range $< \pm 50$ ppb

Warm up

5 minutes over +20 to +30 °C, with respect to 1 hour $< \pm 0.1$ ppm

15 minutes over +20 to +30 °C, with respect to 1 hour $< \pm 0.01$ ppm

External reference input

Frequency 1 to 110 MHz, sine wave

Lock range ± 1 ppm, *nominal*

Amplitude 0 to 10 dBm, *nominal*

Connector 1 SMB snap-on

Impedance 50 Ω , *nominal*

Technical Specifications and Characteristics

Amplitude

Input level

Max safe average total power	+30 dBm (1 W)	
Max DC voltage	25 Vdc	
Max RF input (specified performance)	1 to 2 MHz	0 dBm
	2 to 4 MHz	+4 dBm
	4 to 100 MHz	+12 dBm
	100 MHz to 6 GHz	+30 dBm

Expected input level setting

Range	
Pre-amp ON	-170 to 0 dBm
Pre-amp OFF	-170 to +30 dBm
Pre-amp AUTO ⁷	-170 to +30 dBm
Resolution	0.1 dB

Absolute amplitude accuracy & total absolute amplitude accuracy

Conversion type	Frequency	Full temperature range		Controlled temperature range		@ 46 °C module temp ¹⁰ , typical
		Total absolute amplitude accuracy ⁸	Absolute amplitude accuracy ⁹	Total absolute amplitude accuracy ⁸	Absolute amplitude accuracy ⁹	Total absolute amplitude accuracy ⁸
40 MHz IF filter						
Module temperature within ± 3 °C of alignment, pre-amp ON & OFF						
Image protect	≤ 3 GHz	±1.78 dB	±1.72 dB	±1.27 dB	±1.21 dB	±0.46 dB
	> 3 GHz	±1.54 dB	±1.48 dB	±1.19 dB	±1.13 dB	±0.46 dB
Single	All	±1.47 dB	±1.41 dB	±1.22 dB	±1.17 dB	±0.45 dB
160 MHz IF filter						
Module temperature within ±3 °C of alignment, Pre-amp OFF¹¹						
Image protect	≤ 3 GHz	±1.46 dB	±1.34 dB	±0.96 dB	±0.85 dB	±0.33 dB
	> 3 GHz	±1.54 dB	±1.48 dB	±1.16 dB	±1.09 dB	±0.45 dB
Single	All	±1.18 dB	±1.08 dB	±0.94 dB	±0.86 dB	±0.36 dB
160 MHz IF filter						
Module temperature within ±3 °C of alignment, Pre-amp ON¹²						
Image protect	≤ 3 GHz	±1.68 dB	±1.60 dB	±1.18 dB	±1.10 dB	±0.39 dB
	> 3 GHz	±1.55 dB	±1.49 dB	±1.21 dB	±1.15 dB	±0.45 dB
Single	≤ 3 GHz	±1.09 dB	±0.96 dB	±0.85 dB	±0.72 dB	±0.29 dB
	> 3 GHz	±1.36 dB	±1.28 dB	±1.04 dB	±0.96 dB	±0.39 dB

7. At expected input level ≤ -37 dBm, pre-amp is switched on.

8. Total absolute amplitude accuracy is the total of all amplitude measurement errors. This specification includes the sum of the following individual specifications: linearity, expected input level switching uncertainty, IF bandwidth filter switching uncertainty, absolute amplitude accuracy. The wide range of settings used (i.e., expected input level, etc.) are tested independently. The individual error contributions are calculated as follows: a 99.8 % proportion and 95% confidence are computed for each parameter on a statistically significant number of instruments. The root-sum-square (RSS) of these four independent Gaussian parameters is then taken. To that RSS value, two environmental effects and measurement uncertainty are added. One environmental effect is that of temperature (full and controlled temperature range, as defined above) and the other is the temperature variation of ±3 degrees around a field alignment. Applies over the following subset of settings and conditions: expected input level -50 dBm to +30 dBm; input signals within 60 dB below expected input level; 40 MHz and 160 MHz IF filters; input signal at center frequency over full frequency range.

9. The absolute amplitude accuracy is the amplitude measurement error when only changing frequency. The expected input level, conversion type and IF bandwidth settings remain the same and the error introduced by those parameters are not included. Pre-amp auto/OFF expected input level +10 dBm and -12 dBm. Pre-amp ON expected input level -30 dBm.

10. Typical specifications shown at M9350A downconverter reported module temperature of 46 °C and a corresponding environment temperature of 25 °C.

11. When using pre-amp auto mode, applies for signal level within expected input level > -37 dBm.

12. When using pre-amp auto mode, applies for signal level within expected input level ≤ -37 dBm.

Technical Specifications and Characteristics

Amplitude (continued)

Amplitude repeatability and linearity

	Input signal relative to expected input level setting	Specification
Repeatability		<0.05 dB, nominal
Linearity ¹³	>-35 dB	± 0.12 dB ± 0.03 dB, nominal
	≤ -35 dB	± 0.21 dB ± 0.04 dB, nominal

IF flatness^{14,15}

Analysis bandwidth	IF filter	Nominal
40 MHz	40 MHz	± 0.08 dB
100 MHz	160 MHz	± 0.09 dB
160 MHz	160 MHz	± 0.10 dB

IF phase linearity¹⁵

Analysis bandwidth	Conversion type	Peak to peak, nominal
40 MHz	All	1.0°
100 MHz	Single	0.8°
	Image protect	1.7°
160 MHz	Single	1.4°
	Image protect	1.8°

13. Input level 20 dB above the noise floor and dither on, no change in hardware settings, below expected input level.

14. Amplitude deviation from the mean error of the entire bandwidth, all conversion types.

15. Expected input level 0 dBm. Center frequency ≥ 250 MHz.

Technical Specifications and Characteristics

Amplitude (continued)

IF bandwidth filter switching uncertainty ¹⁶	Specification	Typical	Nominal
	±0.4 dB	±0.15 dB	±0.09 dB

Expected input level switching uncertainty	Specification	Typical	Nominal
Pre-amp Auto/OFF			
Max input to +5 dBm	±0.45 dB	±0.14 dB	±0.10 dB
Crossing +5 dBm	±0.63 dB	±0.24 dB	±0.17 dB
Pre-amp OFF			
+5 to -50 dBm	±0.41 dB	±0.16 dB	±0.11 dB
Pre-amp ON			
+0 to -50 dBm	±0.64 dB	±0.27 dB	±0.21 dB
Pre-amp AUTO			
Crossing -37 dBm	±0.95 dB	±0.19 dB	±0.12 dB

Amplitude switching speed

Arbitrary amplitude change	Standard, nominal	Option UNZ, nominal
List mode switching speed ¹⁷	≤ 5 ms	≤ 136 μs
Non-list mode switching speed ¹⁸	≤ 5 ms	≤ 1.5 ms

Input voltage standing wave ratio (VSWR)

Input voltage standing wave ratio (VSWR)	Nominal
< 10 MHz	1.7:1
10 MHz to 2.5 GHz	1.4:1
> 2.5 GHz	1.7:1

16. Amplitude error relative to the reference IF bandwidth filter of 40 MHz.

17. Settled to within 0.1 dB of final value. Does not include data acquisition or processing time. When used with the M9018A PXIe chassis (2-link configuration: 1 x 8 [factory default]) and the M9036A PXIe embedded controller.

18. Mean time from IVI command to amplitude settled.

Technical Specifications and Characteristics

Dynamic range

Displayed average noise level (DANL) ¹⁹

Conversion type	Frequency	Specification	Nominal
Pre-amp OFF Image protect	< 100 MHz		-145 dBm/Hz
	100 to < 700 MHz	-137 dBm/Hz	-147 dBm/Hz
	700 MHz to < 5.75 GHz	-140 dBm/Hz	-148 dBm/Hz
	5.75 to 6 GHz	-129 dBm/Hz	-146 dBm/Hz
Single	<1.2 GHz	-148 dBm/Hz	-154 dBm/Hz
	1.2 to 3.1 GHz	-143 dBm/Hz	-152 dBm/Hz
	> 3.1 to < 5.4 GHz	-138 dBm/Hz	-149 dBm/Hz
	5.4 to 6 GHz	-133 dBm/Hz	-148 dBm/Hz
Pre-amp ON Image protect	< 100 MHz		-162 dBm/Hz
	100 MHz to < 2.7 GHz	-156 dBm/Hz	-161 dBm/Hz
	2.7 to 4.4 GHz	-155 dBm/Hz	-160 dBm/Hz
	> 4.4 to < 5.6 GHz	-152 dBm/Hz	-157 dBm/Hz
	5.6 to 6 GHz	-141 dBm/Hz	-154 dBm/Hz
Single	<1.1 GHz	-157 dBm/Hz	-161 dBm/Hz
	1.1 to < 3.6 GHz	-154 dBm/Hz	-158 dBm/Hz
	3.6 to 5 GHz	-151 dBm/Hz	-156 dBm/Hz
	> 5 to 6 GHz	-146 dBm/Hz	-153 dBm/Hz

Third order intermodulation distortion (TOI) ²⁰

Conversion type: auto	Frequency	TOI ²³		Distortion ²⁴
		Specification	Typical	
Pre-amp OFF ²¹	≤ 400 MHz	+15 dBm	+20.5 dBm	-52 dBc
	> 400 MHz to 3 GHz	+18 dBm	+23 dBm	-52 dBc
	> 3 GHz	+20 dBm	+23.5 dBm	-52 dBc
Pre-amp ON ²²	≤ 100 MHz	-9.9 dBm	-2.5 dBm	-56 dBc
	> 100 to 850 MHz	-7.9 dBm	+2 dBm	-58 dBc
	> 850 MHz to 2 GHz	-4.3 dBm	+5 dBm	-47 dBc
	> 2 to 3 GHz	-0.9 dBm	+7 dBm	-41 dBc
	> 3 to 6 GHz	+1 dBm	+5 dBm	-32 dBc

19. Expected input level of -50 dBm. Mixer level offset +10 dB.

20. Two tone, 100 kHz tone spacing.

21. Expected input level -5 dBm. Mixer level offset +10 dB.

22. Expected input level -25 dBm. Mixer level offset +15 dB.

23. TOI = third order intercept. The TOI is given by the input tone level (in dBm) minus (distortion/2) where distortion is the relative level of the distortion tones in dBc.

24. Expected input level -10 dBm with preamp off and -30 dBm with preamp on.

Technical Specifications and Characteristics

Dynamic range (continued)

Second harmonic distortion (SHI)

Conversion type: image protect Pre-amp OFF ²⁵	Frequency	SHI, nominal ²⁶	Distortion, nominal ²⁷
	≤ 1.35 GHz	+35 dBm	- 45 dBc
	> 1.35 GHz	+95 dBm	-105 dBc

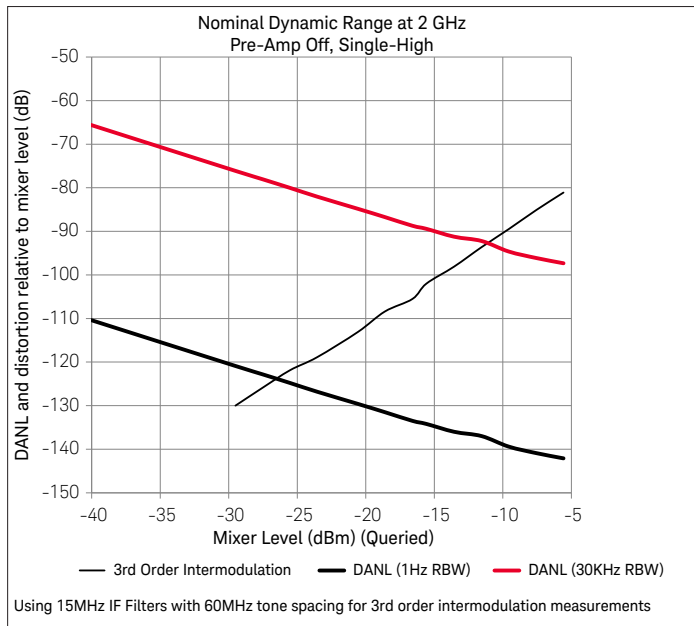

Figure 4. Dynamic range at 2 GHz, pre-amp OFF, single-high conversion type.

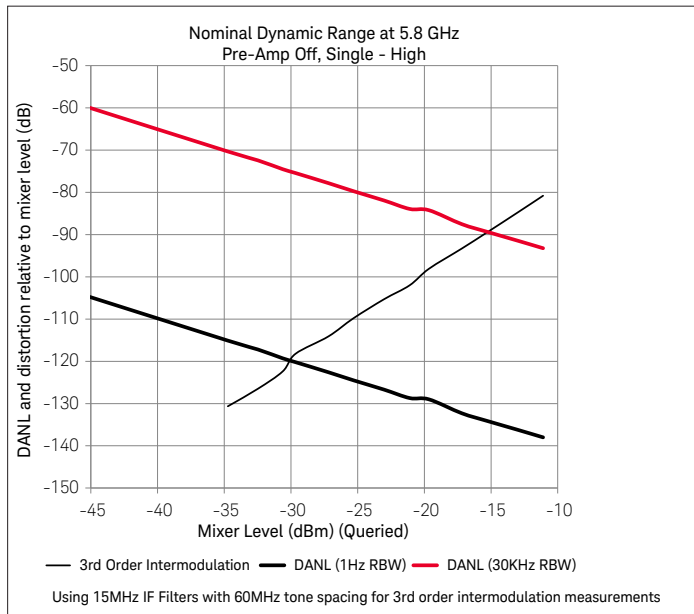

Figure 5. Dynamic range at 5.8 GHz, pre-amp OFF, single-high conversion type.

25. Expected input level -10 dBm. Mixer level offset +10 dB.

26. SHI = second harmonic intercept. The SHI is given by the input power in dBm minus the second harmonic distortion level relative to the input signal in dBc.

27. For 0 dBm input signal.

Technical Specifications and Characteristics

Dynamic range (continued)

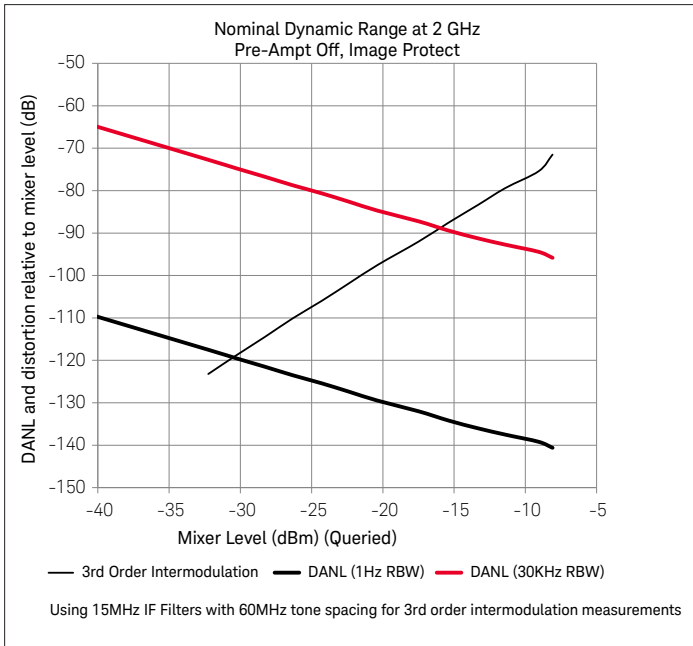

Figure 6. Dynamic range at 2 GHz, pre-amp OFF, image protect conversion type.

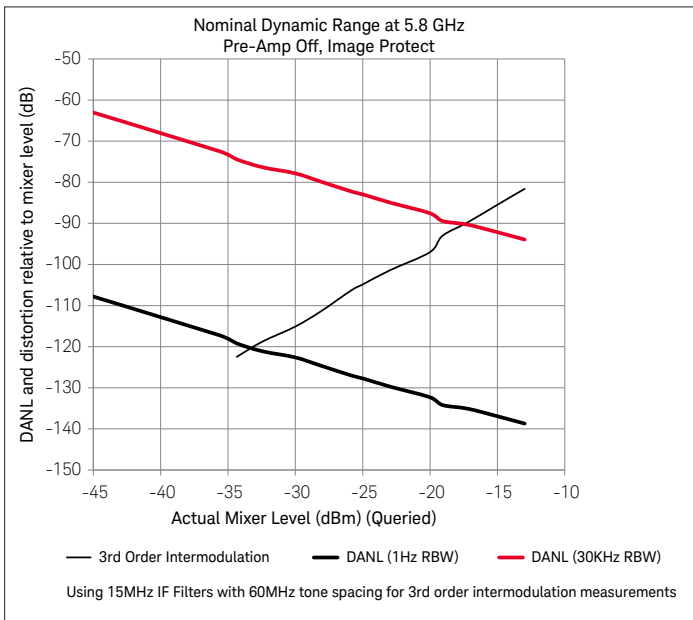

Figure 7. Dynamic range at 5.8 GHz, pre-amp OFF, image protect conversion type.

Technical Specifications and Characteristics

Spectral purity

Phase noise²⁸

Conversion type	Center frequency	Offset	Nominal
Single low	1.1 GHz	10 kHz	-120 dBc/Hz
Single high	1 GHz	10 kHz	-119 dBc/Hz

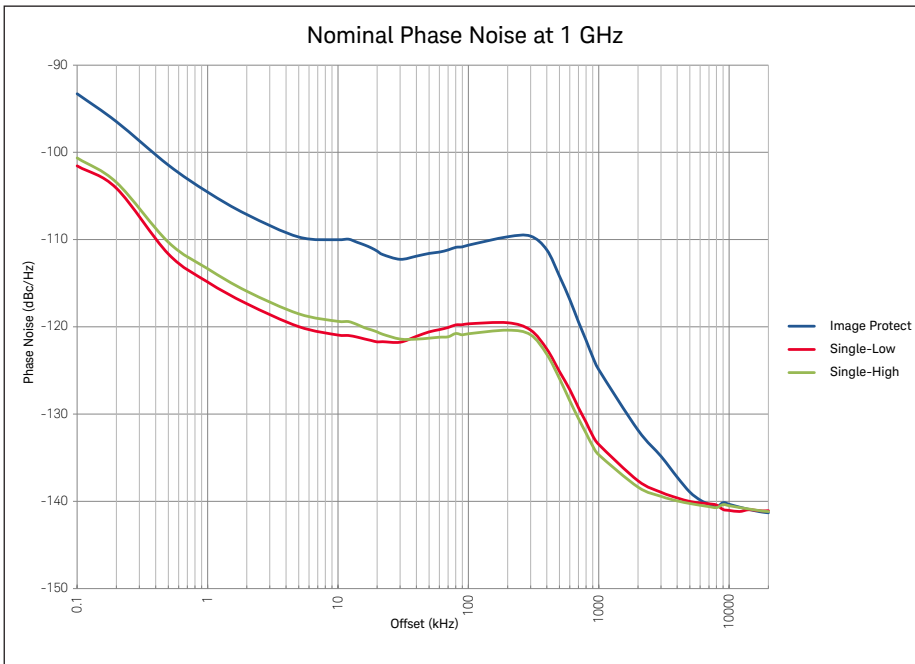

Figure 8. Phase noise at 1 GHz (1.1 GHz for single-low conversion type).

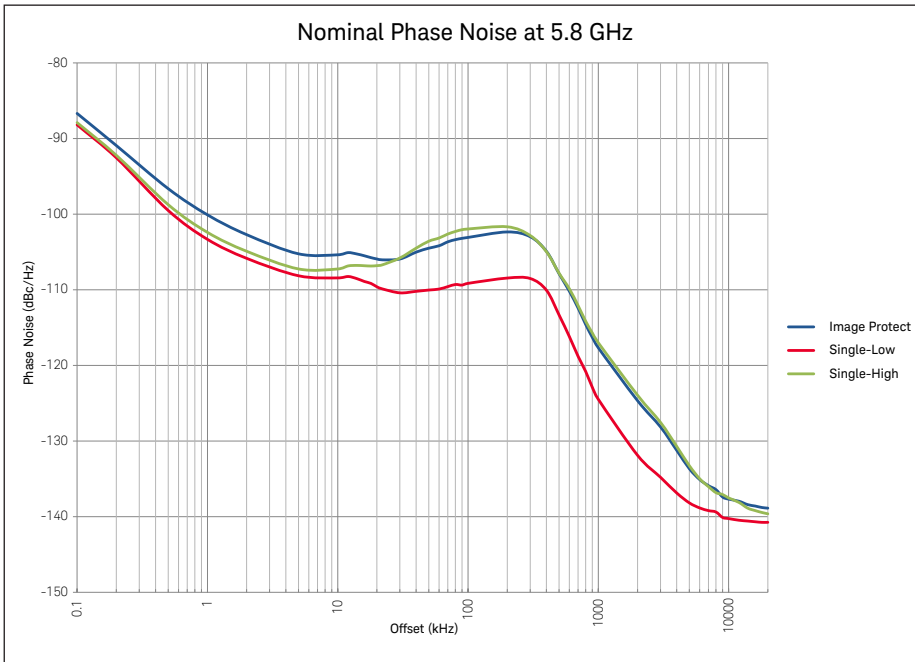

Figure 9. Phase noise at 5.8 GHz.

28. Mixer level offset +20 dB.

Technical Specifications and Characteristics

Spectral purity (continued)

Residuals, images & spurious responses

Non-input related spurs ²⁹	Conversion type	Frequency	Nominal
Expected input level			
Pre-amp ON			
≤ 0 dBm (measured at -50 dBm)	Single	All	< -120 dBm
	Image protect	All ³⁰	< -120 dBm
Pre-amp OFF			
< +5 dBm (measured at -50 dBm)	Single	≤ 3 GHz	< -120 dBm
		> 3 GHz	< -116 dBm
	Image protect	All ³¹	< -105 dBm
≥ +5 dBm (measured at +6 dBm)	Single	All	< -98 dBm
	Image protect	All ³²	< -90 dBm
LO related spurs ³³			
	Offsets from carrier	Frequency	Nominal
	200 to 10 kHz	All	-82 dBc
	10 kHz to 10 MHz	All	-55 dBc
First order RF spurious responses ³⁴			
	Offsets from carrier	Frequency	Nominal
	≥ 10 MHz	≥ 200 MHz to 6 GHz	-60 dBc
Higher order RF spurious responses ³⁴			
	Offsets from carrier	Frequency	Nominal
	≥ 10 MHz	≥ 200 MHz to 6 GHz	-60 dBc
Image responses ³⁵			
	Conversion type	Frequency	Nominal
	Image protect	All	< -68 dBc
IF rejection ³⁶			
	IF bandwidth filter	Frequency	Nominal
15 MHz		≤ 400 MHz	< -57 dBc
		> 400 MHz	< -105 dBc
40 MHz		≤ 450 MHz	< -57 dBc
		> 450 MHz	< -98 dBc
160 MHz		All	< -85 dBc
LO emission ³⁷			
	Conversion type	Frequency	Nominal
Single		≤ 3 GHz	-72 dBm
		> 3 GHz	-62 dBm
Image protect		All	-88 dBm

29. Mixer level offset at 10 dB, input terminated, with 50Ω load.

30. From 4.72 to 4.88 GHz, specification at <-108 dBm, nominal.

31. From 4.72 to 4.88 GHz, specification at <-96 dBm, nominal.

32. From 4.72 to 4.88 GHz, specification at <-80 dBm, nominal.

33. Expected input level 0 dBm. Mixer offset level -10 dB.

34. Conversion type: image protect, pre-amp OFF, expected input level -20 dBm and mixer level offset 0 dB.

35. Excitation frequency: [F=2*Final IF] MHz, expected input level -20 dBm, mixer level offset -30 dB.

36. Suppression of signal at IF frequencies when tuned at least 2 x IF BW away. All input paths, image protect, expected input level -30 dBm. Input signal at -30 dBm and mixer level offset 0 dB.

37. Expected input level -50 dBm. Mixer level offset +10 dB.

Technical Specifications and Characteristics

Data acquisition

Maximum capture memory	Non-list mode	List mode
Option M01	128 MSample (512 MB)	128 MSample (512 MB)
Option M05	512 MSample (2 GB)	512 MSample (2 GB)
Option M10	1 GSample (4 GB) ³⁸	512 MSample (2 GB) to ~ 1 GSample (3.999 GB) ³⁹
Segments		
Minimum length	1 sample ⁴⁰	
Maximum length	Full capture memory ³⁸	
Maximum sample rate		
Option B04 / 40 MHz	50 MS/s complex, 100 MS/s real	
Option B10 / 100 MHz	125 MS/s complex, 250 MS/s real	
Option B16 / 160 MHz	200 MS/s complex, 400 MS/s real	
List mode		
Maximum number of segments	3201	
Trigger sources	External, magnitude	
Trigger modes	Per acquisition, interval timer trigger	
Triggering		
Delay range ⁴¹	-500 ms to +500 ms, <i>nominal</i>	
Delay resolution	1 sample, <i>nominal</i>	
External trigger signal frequency range	10 to 30 MHz for pulse	
External trigger signal level	TTL	
External trigger signal duty cycle range	20% to 80%	
External trigger signal waveform	Sine, pulse/square, ramp (symmetry 0% to 100%)	

Channel-to-channel synchronization⁴²

	Timing	Phase
Skew	≤ 400 ps, <i>nominal</i>	-
Jitter ⁴³	≤ 50 ps, <i>nominal</i>	$\leq 0.3^\circ$, <i>nominal</i>
Repeatability ⁴⁴	≤ 80 ps, <i>nominal</i>	$\leq 1.0^\circ$, <i>nominal</i>
Adjustment resolution ⁴⁵	50 ps	0.05°
Drift over 12 hours	20 ps, <i>nominal</i>	0.5°, <i>nominal</i>

38. The default mode for allocation of capture memory is AgM9391MemoryModeNormal, where the digitizer's memory is shared by both the default single acquisition (capture ID = 0) and all the other acquisitions with non-zero capture IDs. In particular, the memory for the default single acquisition is allocated from the area unused by the list acquisitions. If the available memory is not sufficient for the single acquisition, the user must release memory allocated for the non-zero capture ID acquisitions manually, thus increasing free space. Total memory usage is limited according to the memory option. Note that the maximum size of acquisition is 2 GB in this mode. To perform the default single acquisition with memory size larger than 2 GB, AgM9391MemoryModeLargeAcquisition must be selected. The non-zero capture ID acquisitions cannot be performed in this mode. All data acquired with AgM9391MemoryMode Normal will be invalidated.

39. The maximum size for a single list point capture is limited to 512 MSamples (2 GB). However, with option M10, total capture of up to 3.999 GB is available across all list mode captures.

40. 64-bit mode, 2 samples for 32-bit mode.

41. Negative trigger delay limited to capture size.

42. Multi-channel capability only supported with up to 8-channels when configured with a Keysight M9018A PXIe chassis with FPGA version 1.05 or greater. Characteristics measured at 400, 900, 2400, 5800 MHz and apply in Auto Conversion mode at frequencies ≥ 400 MHz with IF filter = 160 MHz. V2802A LO distribution network used for phase synchronization for more than 4 channels.

43. Jitter indicates measurement-to-measurement variation and applies over short time interval at room temperature without resetting or reinitializing a driver session.

44. Repeatability indicates stability of alignment between channels across power cycles and IVI sessions, with identical cabling and hardware settings (frequency, span, sample rate, etc.)

45. Channel time and phase offsets can be adjusted using OffsetDelay and OffsetPhase properties respectively.

Technical Specifications and Characteristics

Measurement speed⁴⁶

IQ data capture ⁴⁷	Nominal	
Large block (50 MSamples)	1.5 s	Transferred in 100 kSa or 1 MSa blocks
Small block (100 captures, 100 ksamples each)	292 ms	Transferred in 10 kSa blocks
Adjust level, freq (10 ksamples)	1.7 ms	Transferred in 10 kSa blocks

Power measurements ⁴⁸			
Channel power settings & filter bandwidth	Acquisition Time	Averages	Nominal
3.84 MHz	400 μ s	None	1.8 ms
		10	7.6 ms
	100 μ s	None	1.3 ms
		10	4.1 ms
	50 μ s	None	1.3 ms
		10	3.4 ms
30 kHz	100 μ s	None	3.9 ms
		10	30.4 ms

46. EVM, ACPR and servo loop test times for the RF power amplifier test, reference solution are included in the solution brochure 5991-4104EN.
 47. Capture block, transfer to host memory, 160 MHz BW, excludes frequency transitions below 400 MHz, with M9037A embedded controller (2-link configuration: 1 x 8 [factory default]).
 48. Transfer to host memory, 160 MHz IF bandwidth filter, excludes frequency transitions below 400 MHz, with M9037A embedded controller (2-link configuration: 1 x 8 [factory default]).

Noise Figure Measurement Application

Description	Specifications		Supplemental Information
Noise figure			Uncertainty calculator ⁴⁹
< 10 MHz			See footnote ⁵⁰
10 MHz to 6 GHz			Internal and external preamplification recommended ⁵¹
	Noise source ENR	Measurement range	Instrument uncertainty ⁵²
	4 to 6.5 dB	0 to 20 dB	± 0.054 dB
	12 to 17 dB	0 to 30 dB	± 0.102 dB
	20 to 22 dB	0 to 35 dB	± 0.119 dB

49. The figures given in the table are for the uncertainty added by the X-Series Signal Analyzer instrument only. To compute the total uncertainty for your noise figure measurement, you need to take into account other factors including: DUT NF, Gain and Match, Instrument NF, Gain Uncertainty and Match; Noise source ENR uncertainty and Match. The computations can be performed with the uncertainty calculator included with the Noise Figure Measurement Personality. Go to Mode Setup then select Uncertainty Calculator. Similar calculators are also available on the Keysight web site; go to <http://www.keysight.com/find/nfu>.
 50. Uncertainty performance of the instrument is nominally the same in this frequency range as in the higher frequency range. However, performance is not warranted in this range. There is a paucity of available noise sources in this range, and the analyzer has poorer noise figure, leading to higher uncertainties as computed by the uncertainty calculator.
 51. The NF uncertainty calculator can be used to compute the uncertainty. For most DUTs of normal gain, the uncertainty will be quite high without preamplification.
 52. "Instrument Uncertainty" is defined for noise figure analysis as uncertainty due to relative amplitude uncertainties encountered in the analyzer when making the measurements required for a noise figure computation. The relative amplitude uncertainty depends on, but is not identical to, the relative display scale fidelity, also known as incremental log fidelity. The uncertainty of the analyzer is multiplied within the computation by an amount that depends on the Y factor to give the total uncertainty of the noise figure or gain measurement. See Keysight App Note 57-2, literature number 5952-3706E for details on the use of this specification. Jitter (amplitude variations) will also affect the accuracy of results. The standard deviation of the measured result decreases by a factor of the square root of the Resolution Bandwidth used and by the square root of the number of averages. This application uses the 4 MHz Resolution Bandwidth as default because this is the widest bandwidth with uncompromised accuracy.

Description	Specifications	Supplemental Information
Gain		
Instrument uncertainty ⁵³		DUT gain range = -20 to +40 dB. See note ⁵⁴
< 10 MHz		
10 MHz to 6 GHz	± 0.21 dB	

53. "Instrument Uncertainty" is defined for gain measurements as uncertainty due to relative amplitude uncertainties encountered in the analyzer when making the measurements required for the gain computation. See Keysight App Note 57-2, literature number 5952-3706E for details on the use of this specification. Jitter (amplitude variations) will also affect the accuracy of results. The standard deviation of the measured result decreases by a factor of the square root of the Resolution Bandwidth used and by the square root of the number of averages. This application uses the 4 MHz Resolution Bandwidth as default since this is the widest bandwidth with uncompromised accuracy. Under difficult conditions (low Y factors), the instrument uncertainty for gain in high band can dominate the NF uncertainty as well as causing errors in the measurement of gain. These effects can be predicted with the uncertainty calculator.
54. Uncertainty performance of the instrument is nominally the same in this frequency range as in the higher frequency range. However, performance is not warranted in this range. There is a paucity of available noise sources in this range, and the analyzer has poorer noise figure, leading to higher uncertainties as computed by the uncertainty calculator.

Description	Specifications	Supplemental Information
Noise figure uncertainty calculator ⁵⁵		
Instrument noise figure uncertainty	See the noise figure table earlier in this chapter	
Instrument gain uncertainty	See the gain table earlier in this chapter	
Instrument noise figure		See graphs of "nominal instrument noise figure"; noise figure is DANL + 176.24 dB (nominal) ⁵⁶
Instrument input match		See graphs: nominal VSWR

55. The Noise Figure Uncertainty Calculator requires the parameters shown in order to calculate the total uncertainty of a Noise Figure measurement.
56. Nominally, the noise figure of the spectrum analyzer is given by $NF = D - (K - L + N + B)$ where D is the DANL (displayed average noise level) specification, K is kTB (-173.98 dBm in a 1 Hz bandwidth at 290 K) L is 2.51 dB (the effect of log averaging used in DANL verifications) N is 0.24 dB (the ratio of the noise bandwidth of the RBW filter with which DANL is specified to an ideal noise bandwidth) B is ten times the base-10 logarithm of the RBW (in hertz) in which the DANL is specified. B is 0 dB for the 1 Hz RBW. The actual NF will vary from the nominal due to frequency response errors.

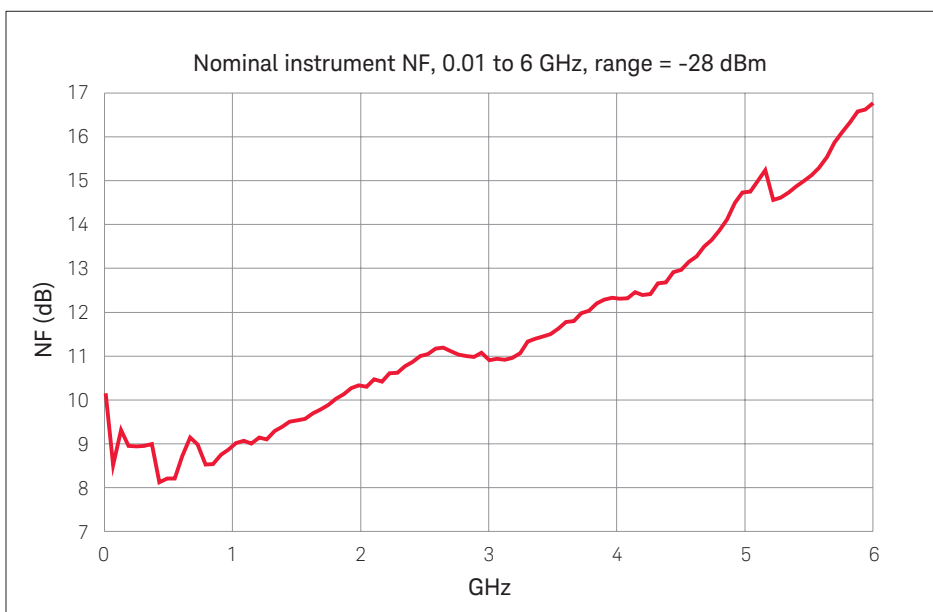

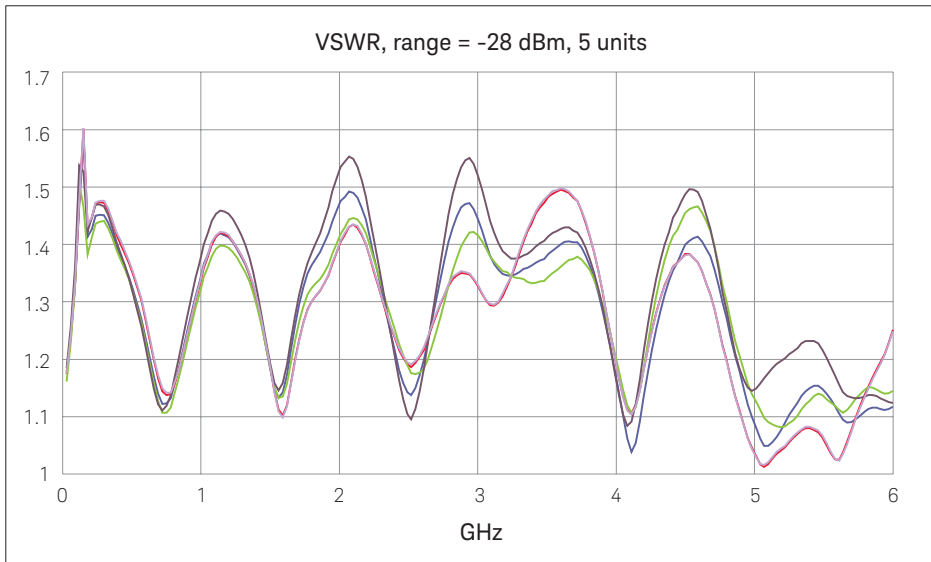

Format specific measurement data

GSM 57, 58

	Parameters	Nominal
Global phase error	0.9, 1.8, 1.9, 2.0, 2.1, 2.2 GHz	0.17°
ORFS dynamic range	200 kHz offset	-36 dBc
	250 kHz offset	-41 dBc
	400 kHz offset	-69 dBc
	600 kHz offset	-73 dBc
	800 kHz offset	-77 dBc
	1200 kHz offset	-80 dBc
	1800 kHz offset	-78 dBc

EDGE 57, 58

	Parameters	Nominal
Residual EVM	0.9, 1.8, 1.9, 2.0, 2.1, 2.2 GHz	0.23% rms
ORFS dynamic range	200 kHz offset	-37 dBc
	250 kHz offset	-42 dBc
	400 kHz offset	-69 dBc
	600 kHz offset	-73 dBc
	800 kHz offset	-77 dBc
	1200 kHz offset	-80 dBc
	1800 kHz offset	-77 dBc

57. Synthesizer PLL mode set to PLL mode best wide offset.

58. Expected input level 0 dBm, input signal (total power) 0 dBm, mixer level offset +10 dB, conversion type: Auto, PeakToAverage set per signal peak to average.

Technical Specifications and Characteristics

Format specific measurement (continued)

W-CDMA ^{59, 60}	Parameters		Typical	Nominal	
Residual EVM	2 GHz, 1 DPCH, 1 carrier			0.5%	
ACLR dynamic range	2 GHz, 1 DPCH, 1 carrier (power mode)	Adjacent	-68.1 dBc	-69.8 dBc	
		Alternate	-70.7 dBc	-71.7 dBc	
802.11g ^{59, 60, 64}	Parameters			Nominal	
EVM	2.4 GHz, 20 MHz BW			-52.8 dB	
802.11a ^{59, 60, 64}	Parameters			Nominal	
EVM	5.8 GHz, 20 MHz BW			-48.1 dB	
802.11n ^{59, 60, 64}	Parameters			Nominal	
EVM	2.4 GHz, 40 MHz BW	1-channel	-52.0 dB	2-channel ⁶²	-50.6 dB
		3-channel ⁶²	-50.9 dB	4-channel ⁶²	-50.9 dB
EVM	5.8 GHz, 40 MHz BW	1-channel	-48.6 dB	2-channel ⁶²	-45.3 dB
		3-channel ⁶²	-46.0 dB	4-channel ⁶²	-46.0 dB
802.11ac ^{59, 60}	Parameters			Nominal	
EVM ⁶³	5.8 GHz, 80 MHz BW	1-channel	-46.5 dB	2-channel ⁶²	-43.0 dB
		3-channel ⁶²	-43.6 dB	4-channel ⁶²	-41.2 dB
EVM ⁶³	5.8 GHz, 160 MHz BW	1-channel	-44.7 dB	2-channel ⁶²	-41.7 dB
		3-channel ⁶²	-43.3 dB	4-channel ⁶²	-40.1 dB
EVM ⁶³	5.8 GHz, 80 MHz BW	1-channel	-49.4 dB	2-channel ⁶²	-47.3 dB
		3-channel ⁶²	-46.4 dB	4-channel ⁶²	-42.3 dB
EVM ⁶³	5.8 GHz, 160 MHz BW	1-channel	-47.5 dB	2-channel ⁶²	-44.7 dB
		3-channel ⁶²	-45.1 dB	4-channel ⁶²	-40.1 dB
SEM	5.8 GHz, 80 MHz BW	see Figure 10			
802.11a/g ^{62, 60}	Parameters				
SEM	2.4 GHz	see Figure 11			
	5.5 GHz	see Figure 12			
802.11e ^{62, 60, 65}	Parameters				
OFDMA WiMAX™ EVM	2.5, 3.5, & 5.8 GHz	-48.3 dB, nominal			

59. Synthesizer PLL mode set to PLL mode best wide offset.

60. Expected input level 0 dBm, input signal (total power) 0 dBm, conversion type: Auto. PeakToAverage set per signal peak to average.

61. Synthesizer PLL mode set to PLL mode normal.

62. Multi-channel performance data applies when each channel is configured with its own independent synthesizer. Sharing a single synthesizer will degrade EVM performance approximately 1 dB.

63. Mixer level offset = +5 dB

64. Mixer level offset = +10 dB

65. Mixer level offset = +15 dB

Technical Specifications and Characteristics

Format specific measurement (continued)

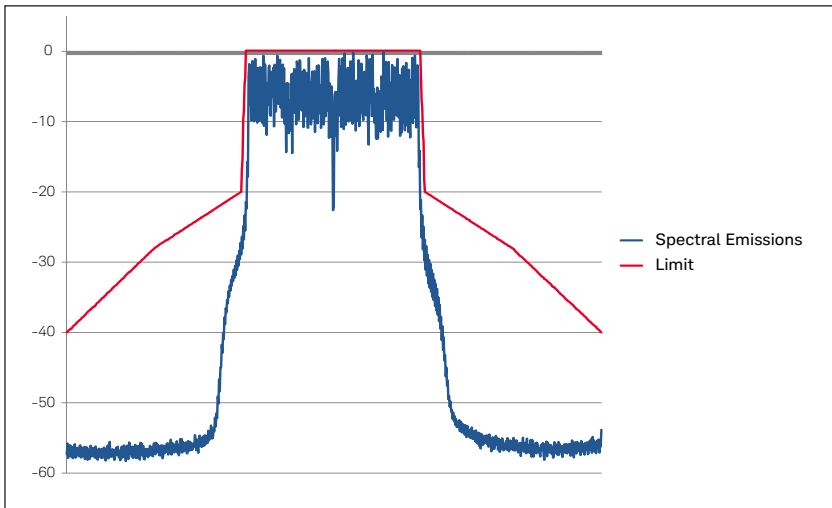

Figure 10. WLAN 802.11ac SEM at 5.8 GHz, 80 MHz bandwidth.

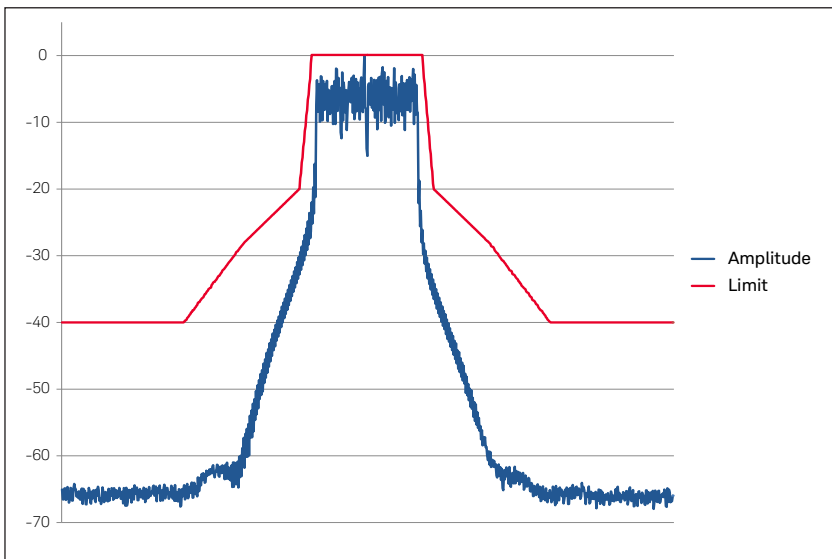

Figure 11. WLAN 802.11a/g SEM at 2.4 GHz, 20 MHz bandwidth.

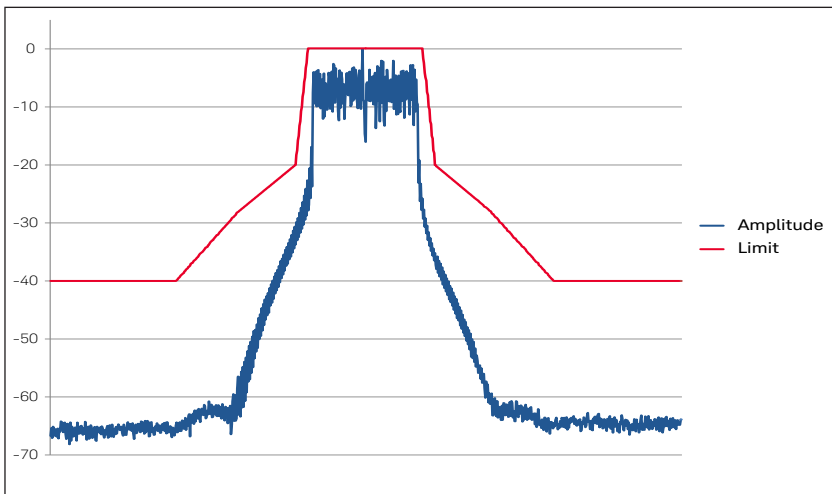

Figure 12. WLAN 802.11a/g SEM at 5.5 GHz, 20 MHz bandwidth.

Technical Specifications and Characteristics

Format specific measurement (continued)

LTE FDD - single channel ^{66, 67}	Parameters	1-channel, nominal		
10 MHz BW EVM, E-TM 3.1 ^{61, 62}	0.7, 0.9 GHz	<i>-52.2 dB (0.25%)</i>		
	1.8, 1.9, 2.0, 2.1, 2.2 GHz	<i>-51.0 dB (0.28%)</i>		
10 MHz BW ACLR, E-TM 1.1 ⁶³	0.7, 0.9, 1.8, 1.9, 2.0, 2.1, 2.2 GHz (power mode)	Adjacent	<i>-64.2 dBc</i>	
		Alternate	<i>-65.5 dBc</i>	
LTE FDD - MIMO ^{66, 67, 68}	Parameters	2-channel, nominal ⁷²	4-channel, nominal ⁷²	8-channel, nominal ⁷³
	0.9 GHz	<i>-49.8 dB (0.32%)</i>	<i>-50.1 dB (0.31%)</i>	<i>-52.6 dB (0.23%)</i>
	2.0 GHz	<i>-49.2 dB (0.35%)</i>	<i>-49.3 dB (0.34%)</i>	<i>-48.8 dB (0.36%)</i>
LTE TDD - MIMO ^{66, 67, 68}	Parameters	2-channel, nominal ⁷²	4-channel, nominal ⁷²	8-channel, nominal ⁷³
	0.9 GHz	<i>-50.7 dB (0.29%)</i>	<i>-50.3 dB (0.31%)</i>	<i>-56.3 dB (0.15%)</i>
	2.0 GHz	<i>-49.0 dB (0.36%)</i>	<i>-49.0 dB (0.36%)</i>	<i>-54.8 dB (0.18%)</i>

66. Expected input level 0 dBm, input signal (total power) 0 dBm, conversion type: Auto. PeakToAverage set per signal peak to average.

67. Synthesizer PLL mode set to PLL mode normal.

68. Multi-channel performance data applies when each channel is configured with its own independent synthesizer. Sharing a single synthesizer will degrade EVM performance approximately 1 dB.

69. PDCCH power boost = 1.065 dB

70. Mixer level offset = +10 dB

71. Mixer level offset = +15 dB

72. 10 MHz BW EVM, R9 downlink, 64 QAM, open loop spatial multiplexing

73. 10 MHz BW, DL, TM9 multi-layer, TM4 closed loop spatial multiplexing

Technical Specifications and Characteristics

Environmental and physical specifications

Temperature	Operating	Individual module temp 25 to 75 °C as reported by the module and environment temp of 0 to 55 °C		
	Non-operating (storage)	Environment temp of -40 to +70 °C		
Humidity ⁷⁴	Type tested at 95%, +40 °C (non-condensing)			
Shock/vibration ⁷⁴	Operating random vibration	Type tested at 5 to 500 Hz, 0.21 g rms		
	Survival random vibration	Type tested at 5 to 500 Hz, 2.09 g rms		
	Functional shock	Type tested at half-sine, 30 g, 11 ms		
	Bench handling	Type tested per MIL-PRF-28800F		
Altitude	Up to 15,000 feet (4,572 meters) ⁷⁵			
Connectors	RF In	SMA female		
EMC	Complies with European EMC Directive 2004/108/EC			
	<ul style="list-style-type: none"> - IEC/EN 61326-2-1 - CISPR Pub 11 Group 1, class A - AS/NZS CISPR 11 - ICES/NMB-001 This ISM device complies with Canadian ICES-001. Cet appareil ISM est conforme a la norme NMB-001 du Canada.			
Warm-up time	45 minutes			
Size	M9300A	1 PXIe slot		
	M9301A	1 PXIe slot		
	M9350A	1 PXIe slot		
	M9214A	1 PXIe slot		
Dimensions	Module	Length	Width	Height
	M9300A	210 mm	22 mm	130 mm
	M9301A	210 mm	22 mm	130 mm
	M9350A	210 mm	22 mm	130 mm
	M9214A	210 mm	22 mm	130 mm
Weight	M9300A	0.55 kg (1.21 lbs)		
	M9301A	0.54 kg (1.19 lbs)		
	M9350A	0.56 kg (1.23 lbs)		
	M9214A	0.36 kg (0.79 lbs)		
Power drawn from chassis	M9300A	≤ 18 W		
	M9301A	≤ 25 W		
	M9350A	≤ 30 W		
	M9214A	≤ 35 W		

74. Samples of this product have been type tested in accordance with the Keysight Environmental Test Manual and verified to be robust against the environmental stresses of storage, transportation and end-use--those stresses include but are not limited to temperature, humidity, shock, vibration, altitude and power-line conditions. Test methods are aligned with IEC 60068-2 and levels are similar to MIL-PRF-28800F Class 3.

75. At 15,000 feet, the maximum environmental temperature is de-rated to 52 °C.

Technical Specifications and Characteristics

System requirements

Topic	Windows 7 requirements
Operating systems	Windows 7 (32-bit and 64-bit)
Processor speed	1 GHz 32-bit (x86), 1 GHz 64-bit (x64) (no support for Itanium 64)
Available memory	4 GB minimum 8 GB or greater recommended
Available disk space ⁷⁶	1.5 GB available hard disk space, includes: 1 GB available for Microsoft .NET Framework 3.5 SP1 ⁷⁷ 100 MB for Keysight IO Libraries Suite
Video	Support for DirectX 9 graphics with 128 MB graphics memory recommended (Super VGA graphics is supported)
Browser	Microsoft Internet Explorer 7 or greater
M9391A vector signal analyzer instrument drivers	
Keysight IO libraries	Version 16.3.17914 or greater

76. Because of the installation procedure, less disk space may be required for operation than is required for installation.

77. NET Framework Runtime Components are installed by default with Windows 7. Therefore, you may not need this amount of available disk space.

Software

Instrument connection software



Keysight IO library

The IO library suite offers a single entry point for connection to the most common instruments including AXIe, PXI, GPIB, USB, Ethernet/LAN, RS-232, and VXI test instruments from Keysight and other vendors. It automatically discovers interfaces, chassis, and instruments. The graphical user interface allows you to search for, verify, and update IVI instrument and soft front panel drivers for modular and traditional instruments. The IO suite safely installs in side-by-side mode with NI I/O software.

Free software download at www.keysight.com/find/iosuite

Module setup and usage

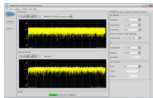

Keysight soft front panel

The PXI module includes a soft front panel (SFP), a software-based graphical user interface (GUI) which enables the instrument's capabilities from your PC.

Included on CD-ROM shipped with module or **online**

Module management

Keysight connection expert

Connection expert is the graphical user interface included in the IO libraries suite that allows you to search for, verify and update IVI instrument and soft front panel drivers for modular and traditional instruments

Free software download at www.keysight.com/find/iosuite

Programming

Driver

IVI-COM, IVI-C
LabVIEW, MATLAB

Development environments

Visual Studio (VB.NET, C#, C/C++), VEE
LabVIEW, LabWindows/CVI, MATLAB

Included on CD-ROM shipped with module.

Programming assistance



Command expert

Assists in finding the right instrument commands and setting correct parameters. A simple interface includes documentation, examples, syntax checking, command execution, and debug tools to build sequences for integration in Excel, MATLAB, Visual Studio, LabVIEW, VEE, and SystemVue.

Free software download at www.keysight.com/find/commandexpert

Programming examples

Each module includes programming examples for Visual Studio, net, LabVIEW, MATLAB, LabWindows, and Keysight VEE Pro.

Included on CD-ROM shipped with module.

Signal analysis software

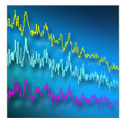

X-Series measurement applications for modular instruments

The X-Series measurement applications transform modular PXI VSAs into standards based RF transmitter testers. Provides conformance measurements for many communications standards including : LTE, WLAN 802.11ac and others.

Licensed software.
For more information, visit www.keysight.com/find/pxi-x-series_apps

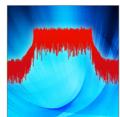

89600 VSA

89600 VSA software sees through the complexity of emerging and existing industry standards, serving as your window into complex signal interactions. Quickly characterize spurs and harmonics with speed-optimized stepped spectrum measurement provided by 89601B-SSA option.

Licensed software.
For more information, visit www.keysight.com/find/vsa



SystemVue

SystemVue is a system-level EDA platform for designing communications and defense systems. Used with the M9391A, SystemVue enables you to create model-based design validation tests to ensure consistency from design to manufacturing.

Licensed software.
For more information, visit www.keysight.com/find/systemvue

Setup and Calibration Services

Assistance

One day startup assistance	Gain access to a technical expert who will help you get started quickly with the M9391A PXI VSA and its powerful software tools. The flexible instruction format is designed to get you to your first measurements and familiarize you with ways to adapt the equipment to a specific application.	Included in base configuration
----------------------------	--	--------------------------------

Calibration and traceability

Factory calibration	The M9391A PXI VSA ships factory calibrated with an ISO-9002, NIST-traceable calibration certificate.	Included in base configuration
Calibration cycle	A one year calibration cycle is recommended.	
Calibration sites	<ul style="list-style-type: none">– At Keysight worldwide service centers– On-site by Keysight– By self-maintainers	For more information visit www.keysight.com/find/infoline
N7800A calibration and adjustment software	The M9391A PXI VSA is supported by Keysight's calibration and adjustment software. This is the same software used at Keysight service centers to automate calibration. The software offers compliance tests for ISO 17025:2005, ANSI/NCSL Z540.3-2006, and measurement uncertainty per ISO Guide to Expression of Measurement Uncertainty.	Licensed software. For more information, visit www.keysight.com/find/calibrationsoftware
Keysight calibration status utility	The Keysight calibration status utility helps ensure your M9391A is calibrated by managing the calibration interval and providing messages regarding instrument and module calibration status.	Included in base configuration

Configuration and Ordering Information

Ordering information

Model	Description
M9391A	PXIe vector signal analyzer: 1 MHz to 3 or 6 GHz Includes: M9301A PXIe synthesizer M9350A PXIe downconverter M9214A PXIe IF digitizer One day startup assistance Module interconnect cables Software, example programs and product information on CD
Base configuration	
M9391A-F03	Frequency range: 1 MHz to 3 GHz
M9391A-B04	Analysis bandwidth, 40 MHz
M9391A-M01	Memory, 128 MSa
M9391A-300	PXIe frequency reference: 10 and 100 MHz Required for warranted specifications
	Adds M9300A PXIe frequency reference: 10 and 100 MHz (M9300A module can support multiple M9391A modular instruments)

For configurations of the M9391A PXI VSA, including combinations with a single or multiple M9381A PXI VSGs, please consult the M9391A & M9381A configuration guide, literature number **5991-0897EN**.

Configurable options	
Frequency	
M9391A-F03	1 MHz to 3 GHz
✓ M9391A-F06	1 MHz to 6 GHz
Switching speed	
✓ M9391A-UNZ	Fast switching
Analysis bandwidth	
M9391A-B04	40 MHz
M9391A-B10	100 MHz
✓ M9391A-B16	160 MHz
Memory	
M9391A-M01	128 MSa
M9391A-M05	512 MSa
✓ M9391A-M10	1024 MSa
Other	
M9391A-012	Phase coherency
M9391A-UK6	Commercial calibration certificate with test data for M9391A (M9301A, M9350A, M9214A)
M9300A-UK6	Commercial calibration certificate with test data for M9300A (module only)
Related products in recommended configuration	
✓ M9037A	PXIe embedded controller
✓ M9018A	18-slot PXIe chassis

✓ Indicates recommended configuration

Configuration and Ordering Information

Software information

Supported operating systems	Microsoft Windows 7 (32/64-bit)
Standard compliant drivers	IVI-COM, IVI-C, LabVIEW, MATLAB
Supported application development environments (ADE)	VisualStudio (VB.NET, C#, C/C++), VEE, LabVIEW, LabWindows/CVI, MATLAB
Keysight IO libraries (version 16.3 or newer)	Includes: VISA libraries, Keysight Connection Expert, IO monitor
Keysight Command Expert	Instrument control for SCPI or IVI-COM drivers
89600 VSA Software (version 17.21 or newer; Option SSA added in version 18.5)	89600B-200 Basic VSA software 89601B-300 Hardware connectivity 89601B-SSA Spectrum analysis 89601B-AYA GP analysis 89601B-B7T cdma2000®/1xEV-DO 89601B-B7U W-CDMA/HSPA+ 89601B-B7R WLAN802.11a/b/g/y/p 89601B-B7X TD-SCDMA 89601B-BHD LTE FDD 89601B-BHG LTE FDD - Advanced 89601B-BHE LTE TDD 89601B-BHH LTE TDD - Advanced
X-Series Measurement Applications for Modular Instruments transportable perpetual license.	M9063A Analog demodulation M9064A Vector signal analysis M9071A GSM/EDGE/Evo M9072A cdma2000®/cdmaOne M9073A W-CDMA/HSPA+ M9076A 1xEV-DO M9077A WLAN 802.11a/b/g/n/ac M9079A TD-SCDMA/HSDPA M9080B LTE/LTE-A FDD M9081A Bluetooth® M9082B LTE/LTE-A TDD

Accessories

Model	Description
Y1212A	Slot blocker kit: 5 modules
Y1213A	PXI EMC filler panel kit: 5 slots
Y1299A	PXI solutions startup kits
Y1243A	Cable kit for M9301A LO distribution
M9021A	PCIe® cable interface
M9045B	PCIe express card adaptor for laptop connectivity
Y1200B	PCIe cable for laptop connectivity
M9048A	PCIe desktop adaptor for desktop connectivity
Y1202A	PCIe cable for desktop connectivity

Related products

Model	Description
M9381A	PXIe vector signal generator
M9380A	PXIe CW source
M9300A	PXIe frequency reference
M9018A	PXIe 18-slot chassis
M9037A	PXIe embedded controller

Learn more at: www.keysight.com

For more information on Keysight Technologies' products, applications or services, please contact your local Keysight office. The complete list is available at: www.keysight.com/find/contactus

